

Dynamic weighing



TeleMetrix

1035 BELT-SCALE



- ✔ Modular design belt scale
- ✔ Enable to be quickly and easily installed on stringer or stockpile conveyor
- ✔ 1 or 2 INOX weight sensor IP67 certified OIML
- ✔ Stabilisation using spring-loaded blade

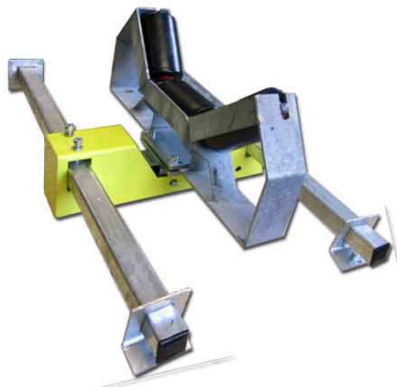

1035 MN1

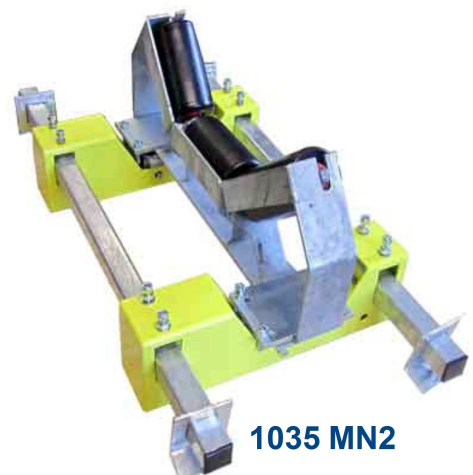

1035 MN2

Belt Scale 1035

Dimensions & implantation

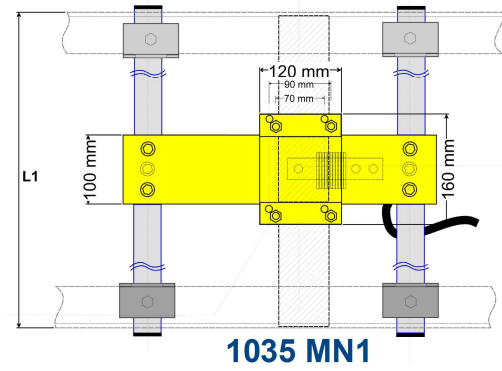
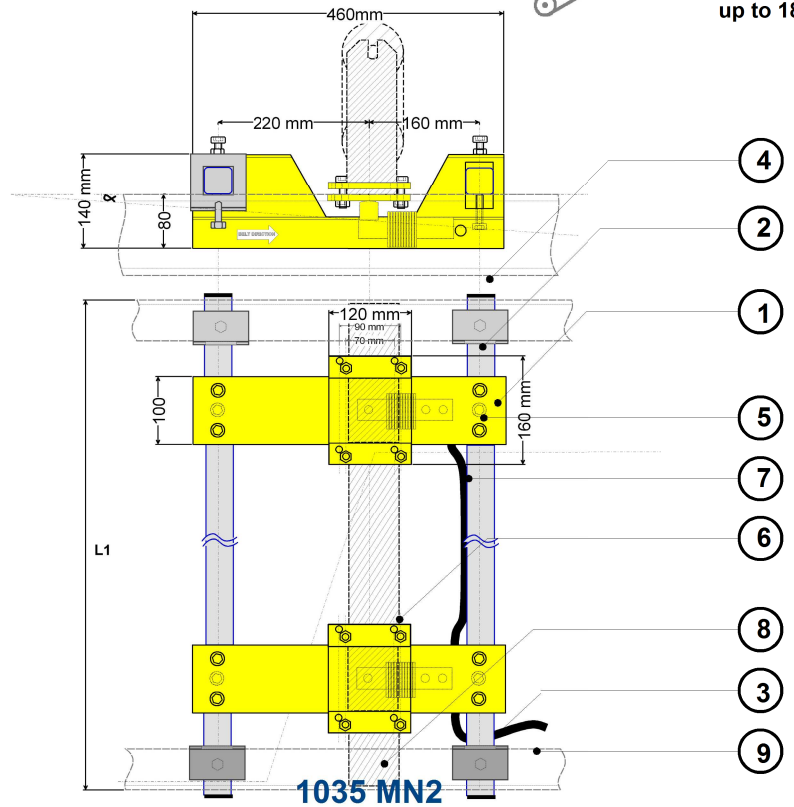
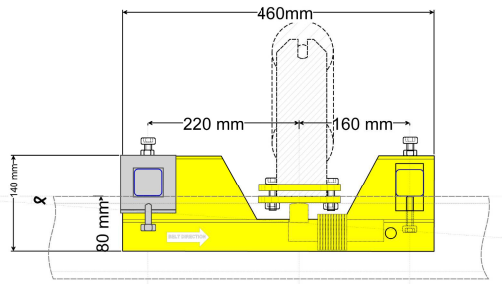
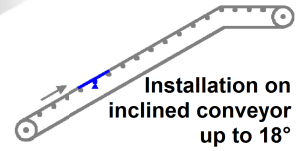

1035 MN1

1035 MN2

1	1 or 2 compartments with weight sensors and stabilisations blades included
2	2 galvanized support bar of 40 x 40 mm, pre-cut L1 = 1200 mm (1500 mm and 2000 mm available upon request)
3	4 adjustment brackets on frame without drilling
4	4 plastic end caps
5	Vertical alignment screws
6	2 or 4 clamps bounding the scale to the weighing compartments
7	Protection tube 16 mm, cable exit with PG9 gland
8	Roller station with 1, 2 or 3 roller sur le convoyeur (not supplied)
9	Conveyor frame (not supplied)

Caractéristiques

Belt Width (mm)	1035 MN1 From 500 to 650 mm	1035 MN2 From 700 to 1400 mm
Belt speed (m/s)	0,1 à 3	
Flow range (t/h)	1 à 200 t/h	10 à 600 t/h
Sensitivity pesage	2 mV/V @ 100 kg/m	1 mV/V @ 100 kg/m
Weight (kg)	32	48
Installation	Delivered asa kit with adjustable stand, no drilling, no soldering, using existant rollers	

Example of several installations

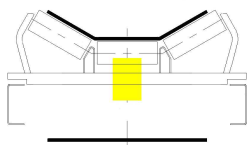

Stinger conveyor
Belt width < 800 mm

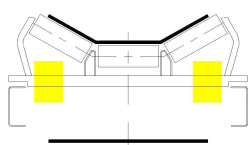

Stinger conveyor
Belt width 800 à 1400 mm

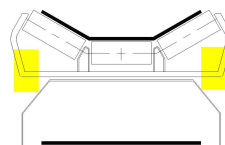

Stockpile conveyor
Belt width 500 à 1400 mm

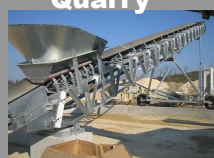
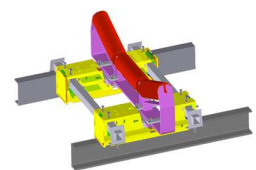

Quarry



Harbour



Mobile plant



Sandpit



Waste treatment

Speed Sensor

Wheel sensor : VTROL

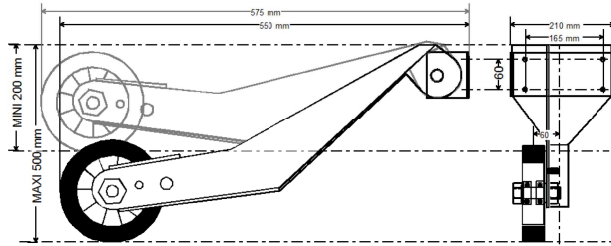

The tachymetric wheel **VTROL** is a ready-made and reliable solution for speed measurement. Easy and quick set up on any conveyor type, easy maintenance, 2-wired or 3-wired cabling.

Roller sensor : TNRV

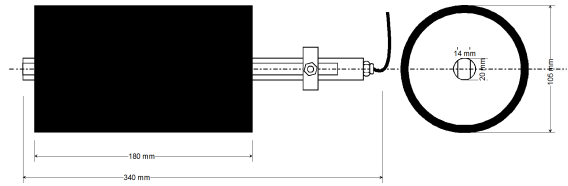

The tachymetric roller **TNRV** is designed to be directly mounted without modification on one of the roller station of common belt scale in quarries. Quick set up, 2-wired or 3-wired cabling.

Weight Calculator

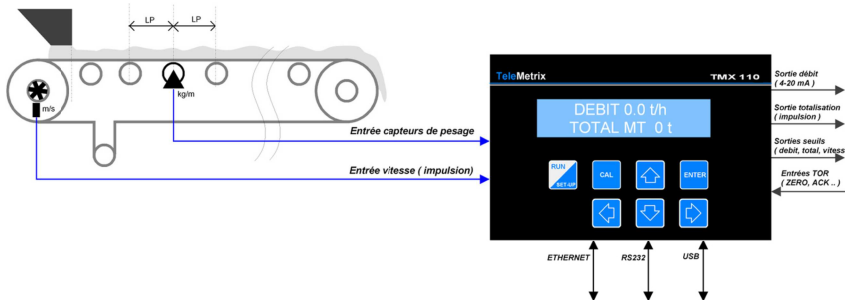

TMX110 Dynamic Weighting Calculator Integrator

- Alphanumeric display of values : debit, total weight, speed, anomaly ...
- Dynamic programme, dosing, weighing screw, flowmeter
- Multi-lingual display : English, French, Dutch, etc. (Available in other languages)
- Available with **WATERPROOF** , **FREE STANDING OR WALL MOUNTING**, **DIN RAIL (transmitter)**.
- Universal communication: standard analogue and numeric connections.
- Auto-calibration and/or testing methods.
- Configuration saving on USB stick.
- Overall auto-diagnostic of the weighing scale's component: sensors, E/S, etc...
- Online and USB updating of the firmware



TMX400 Multi-Connection Weight Calculator

- Clear display of numerical values: debit, total weight, speed, anomaly, **up to 15** weighing scale's connections (NOD400 box)
- Multi-lingual display
- Compact housing wall or DIN rail mounting.
- Universal communication: ethernet, modbus, profibus, analogue connection, USB, ...
- Auto-calibration and/or testing methods.
- Easy setup et remote maintenance



Our expertise

PRODUCTIVE APPLICATIONS

- Continous control and regulation process.
- Daily and weekly counting and totalisation
- Auto-control of truck or wagon loading.
- Stock management.

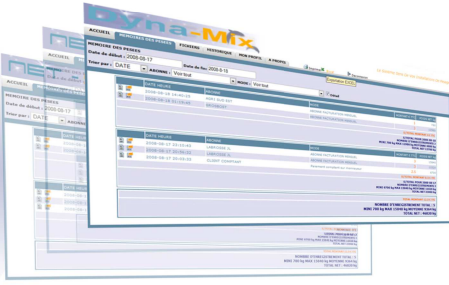
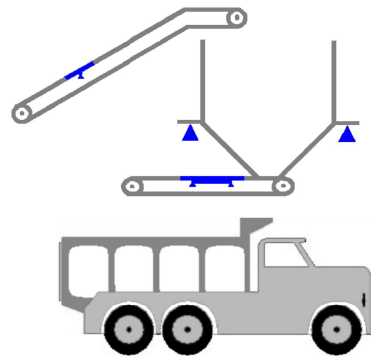

JUSQU'À LA GESTION INFORMATIQUE

DYNAMIX is a software which offers you 3G functionality thus centralized measures, even on distant location. Our softwares ensure connectivity, performance and reliability for your installation.

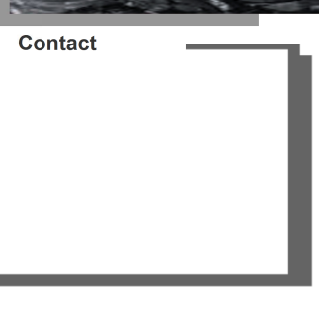
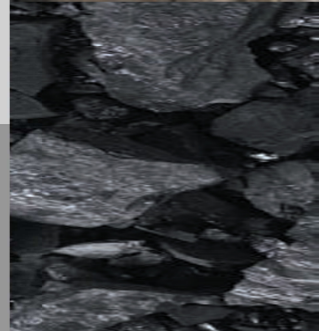

WEIGHING SCREW

The measurement system directly integrates the production line without additional material.

DOSING

Mini weighting belt conveyor allows debit control or continous loading control.

SOLID FLOWMETER CFM

For bulk measurement & regulation :
Cement, peat food cereal, plastic, floor...
High reliability
Low cost

DOSIMETER LWR

Hight precise continous dosing of podery and granule products with varied or fixed density.

STATIC WEIGHING

Weight or hopper placed under silos are precised way for level measurement.

SERVICE SUR SITE

Provide technical services in industrial weighing field: assembly , calibration, breakdown services as maintenance agreement. Our technicians have developed a great experience in the industrial dynamic weighing area with the regulatory requirements.



Calibration on location
Test material and calibration mass

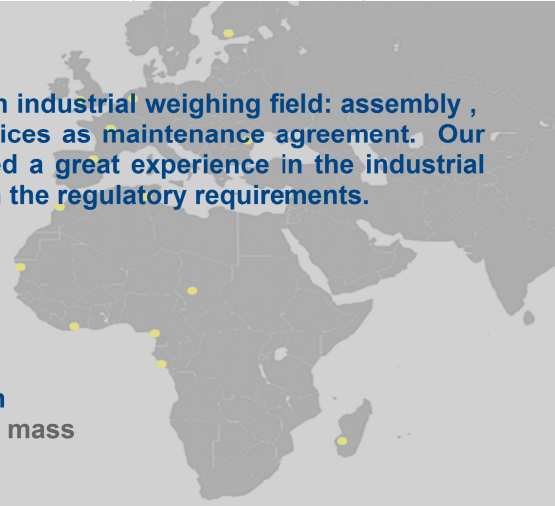

Complementary products

Rotation Controller



Emergency Stop Switch



Tilt Switch Probes



Weight Sensor



Metal Detector



SAS TELEMETRIX®
BP118 79, Rue de la Gare
7370 PLAISIR CEDEX

Head office
Tél. (+33) 0972 11 00 03
Fax. (+33) 0972 11 00 57
contact@telemetrix.fr

SOUTH Office
(+33) 04 84 51 03 00
www.telemetrix.fr

Export
Europe, Afrique,
Asie, etc...
export@telemetrix.fr

Contact

