



Série **Sonde de niveau RADAR**
JFR **Radar Level Transmitter**



www.telemetrix.fr

Pour produit Solide ou Liquide
For liquid and solid application



TeleMetrix

PRODUCT INTRODUCTION

FMCW Radar level transmitter is a non contact measuring device, which is suitable for high temp., high pressure, and corrosive applications. It is easy to install and free of maintenance, especially for the high accuracy requirement environment.

PRINCIPLE

FMCW radar adopts a high frequency signal, which is emitted via an antenna and swipes frequency increment by 0.5GHz during the measurement, reflected by the target surface and received at a time delay. The frequency difference, which is calculated from the transmitting frequency and the received frequency, which is directly proportional to the measured distance (or material surface).

The frequency difference then is processed by Fast Fourier Transformation (FFT) to identify the signal in Intermedium Frequency (IF). This FMCW radar is innate with signal / noise enhancement and filtering of echo-back via Phase-Lock Loop (PLL) circuit that is the best solution for complex environment and high accuracy measurement.

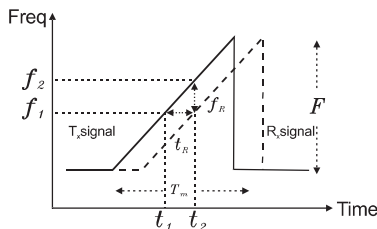

Design formula

$$\text{Slop} = \frac{F}{T_m} = \frac{f_R}{t_R} = \frac{f_R}{\frac{2R}{c}} \quad t_R = \frac{2R}{c}$$

$$R = \frac{F_R \times c \times T_m}{2F}$$

LINEARITY DIAGRAM

Accuracy

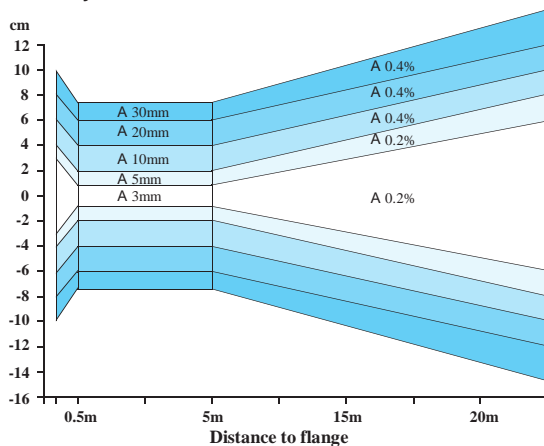

FEATURES

- Non contact measuring
- Corrosive and toxic liquid, hydrocarbons, slurries
- Not affected by specific gravity, pressure, temperature, viscosity, foam, and dust
- 5 digits LCM display
- Indicate signal wave inside the silo.
- Selection of Different Measurement unit(m, cm, mm, inch, ft, %, mA)
- Measuring distance and actual level.
- Language selection of traditional Chinese, simplified Chinese, English.
- 4-20mA/ 4 lead wires
- Modbus RS-485 to enhance isolation and easy for remote control.
- CE standards for isolation(EFT 2000V, B class or better)
- Suitable for mid-range signal
- 4mA, 20mA output
- Set functions to the continuous measuring device via FAS software.
- Isolated circuit design.
- 10GHz JFR1 series could measure liquid material.
- 26GHz JFR2 series could measure all kinds of material.

TEST STANDARDS

- High voltage : IEC60947-2
- Isolated resistance : IEC60092-504
- Power supply change : IEC60092-504
- Power supply failure : IEC60092-504
- Electrical burst testing : IEC61000-4-4
- Voltage DIPS : IEC61000-4-11
- Humidity : IEC60068-2-30
- High/Low temperature test : IEC60068-2-38
- IP protection rating : IEC60529

SPECIFICATION (26GHz 4-wire)

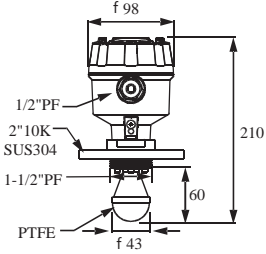
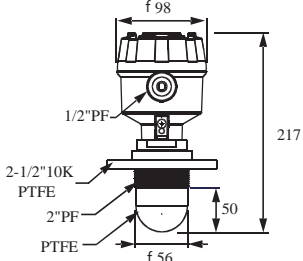
<p>Dimensions (Unit:mm)</p>		
<p>Model</p>	<p>JFR-204</p>	<p>JFR-214</p>
<p>Medium</p>	<p>General liquid and solid</p>	<p>General liquid / suitable for acid and alkaline in liquid</p>
<p>Min. Dielectric constant (solid)</p>	<p>1.5</p>	
<p>Min. Dielectric constant (liquid)</p>	<p>1.4</p>	
<p>Measuring range</p>	<p>Liquid 30m Solid 20m</p>	<p>Liquid 30m</p>
<p>Accuracy</p>	<p>A 3 mm</p>	
<p>Repeatability</p>	<p>A 1 mm</p>	
<p>Digital communication</p>	<p>RS485 (Isolated)</p>	
<p>Ambient temperature</p>	<p>-40~90 °C</p>	
<p>Operating temperature</p>	<p>-40~200 °C</p>	
<p>Operating pressure</p>	<p>0~40 bar</p>	
<p>Frequency</p>	<p>K Band</p>	
<p>Analog output</p>	<p>4~20mA / 4 Wire</p>	
<p>Protection rating</p>	<p>IP67</p>	
<p>Power supply</p>	<p>9.5~30Vdc</p>	
<p>Local display</p>	<p>5 digits LCM display</p>	
<p>Housing material</p>	<p>Aluminum</p>	
<p>Antenna type</p>	<p>Horn (43D)</p>	<p>Lens (56D)</p>
<p>Half-power beam width</p>	<p>± 9°</p>	
<p>Antenna material</p>	<p>SUS316+PTFE</p>	<p>PTFE</p>
<p>Blind distance</p>	<p>500mm</p>	

SPECIFICATION (26GHz 4-wire)

<p>Dimensions (Unit:mm)</p>			
<p>Model</p>	<p>JFR-224</p>	<p>JFR-234</p>	<p>JFR-244</p>
<p>Medium</p>	<p>General liquid and solid</p>		
<p>Suitable For</p>	<p>Long distance measurement</p>	<p>Super distance measurement</p>	<p>Corrosion type acid and alkaline liquid</p>
<p>Min. Dielectric constant (solid)</p>	<p>1.5</p>		
<p>Min. Dielectric constant (liquid)</p>	<p>1.4</p>		
<p>Measuring range</p>	<p>Liquid 30m Solid 20m</p>	<p>Liquid 70m Solid 50m</p>	<p>Liquid 20m Solid 15m</p>
<p>Accuracy</p>	<p>A 3 mm</p>	<p>A 3mm @distance<40m A 0.01%F.S. @distance>40m</p>	<p>A 3 mm</p>
<p>Repeatability</p>	<p>A 1 mm</p>		
<p>Digital communication</p>	<p>RS485 (Isolated)</p>		
<p>Ambient temperature</p>	<p>-40~90 °C</p>		
<p>Operating temperature</p>	<p>-40~200 °C</p>		
<p>Operating pressure</p>	<p>0~40 bar</p>		
<p>Frequency</p>	<p>K Band</p>		
<p>Analog output</p>	<p>4~20mA / 4 Wire</p>		
<p>Protection rating</p>	<p>IP67</p>		
<p>Power supply</p>	<p>9.5~30 Vdc</p>		
<p>Local display</p>	<p>5 digits LCM display</p>		
<p>Housing material</p>	<p>Aluminum</p>		
<p>Antenna type</p>	<p>High gain horn (100)</p>	<p>High gain horn (140)</p>	<p>Lens(43DS)</p>
<p>Half-power beam width</p>	<p>± 5°</p>	<p>± 3°</p>	<p>± 10°</p>
<p>Antenna material</p>	<p>SUS 316</p>		<p>PTFE</p>
<p>Blind distance</p>	<p>500 mm</p>		

P.S. For JFR-224 and JFR-234, customer can connect the compressed air with 1/8"PT thread connector to avoid dust adhered.

SPECIFICATION (10GHz 4-wire)

<p>Dimensions (Unit:mm)</p>		
<p>Model</p>	<p>JFR-10</p>	<p>JFR-11</p>
<p>Medium</p>	<p>General liquid, corrosion liquid (coating)</p>	
<p>Min. dielectric constant</p>	<p>2.5</p>	
<p>Accuracy (1m~5m)</p>	<p>A 5mm</p>	
<p>Repeatability</p>	<p>A 1mm</p>	
<p>Measuring range</p>	<p>30m</p>	<p>20m</p>
<p>Digital communication</p>	<p>RS485(Isolated)</p>	
<p>Ambient temperature</p>	<p>-40~70 ℃</p>	
<p>Operating temperature</p>	<p>-40~200 ℃</p>	
<p>Operating pressure</p>	<p>0~40 bar</p>	
<p>Frequency</p>	<p>X Band</p>	
<p>Analog output</p>	<p>4~20mA / 4 Wire</p>	
<p>Power consumption</p>	<p>100mA/ 24Vdc</p>	
<p>Protection rating</p>	<p>IP65</p>	
<p>Power supply</p>	<p>24Vdc A 10%</p>	
<p>Local display</p>	<p>5 digits LCM display</p>	
<p>Housing material</p>	<p>Aluminum</p>	
<p>Antenna type</p>	<p>Horn(140D)</p>	<p>Horn(100D)</p>
<p>Half-power beam width</p>	<p>± 10°</p>	<p>± 8°</p>
<p>Antenna material</p>	<p>SUS 316/ ETFE Coating</p>	
<p>Sampling rate</p>	<p>1 sec.</p>	
<p>Blind distance</p>	<p>500 mm</p>	

SPECIFICATION (10GHz 4-wire)

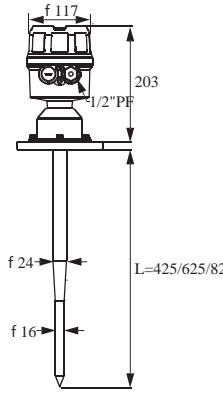
<p>Dimensions (Unit:mm)</p>	
<p>Model</p>	<p>JFR-13F / JFR-14F/ JFR-15F</p>
<p>Medium</p>	<p>General liquid, corrosion liquid (coating)</p>
<p>Min. dielectric constant</p>	<p>4</p>
<p>Accuracy (1m~5m)</p>	<p>A 20mm</p>
<p>Repeatability</p>	<p>A 1mm</p>
<p>Measuring range</p>	<p>10m</p>
<p>Digital communication</p>	<p>RS485(Isolated)</p>
<p>Ambient temperature</p>	<p>-40~70 ℃</p>
<p>Operating temperature</p>	<p>-40~150 ℃</p>
<p>Operating pressure</p>	<p>0~16 bar</p>
<p>Frequency</p>	<p>X Band</p>
<p>Analog output</p>	<p>4~20mA/ 4 Wire</p>
<p>Power consumption</p>	<p>100mA/ 24Vdc</p>
<p>Protection rating</p>	<p>IP65</p>
<p>Power supply</p>	<p>24Vdc A 10%</p>
<p>Local display</p>	<p>5 digits LCM display</p>
<p>Housing material</p>	<p>Aluminum</p>
<p>Antenna type</p>	<p>Rod antenna</p>
<p>Half-power beam width</p>	<p>± 11°</p>
<p>Antenna material</p>	<p>PTFE</p>
<p>Sampling rate</p>	<p>1sec.</p>
<p>Blind distance</p>	<p>600mm</p>

WIRING/CALIBRATION

WIRING INFORMATION

RS485 wiring

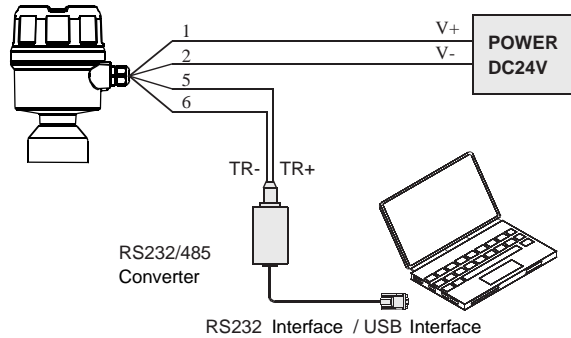

JFR Series and Indicator(External Power)

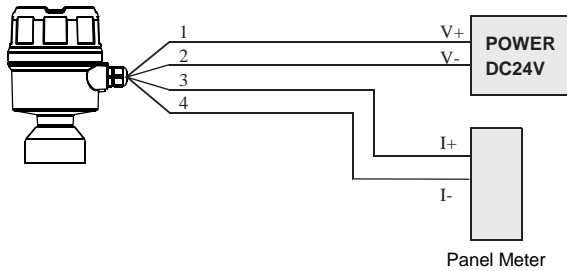

JFR Series and Indicator(Powered by panel meter)



CALIBRATION

Two ways to calibrate the JFR Series:

1. With display/adjustment module
2. By PC based FAS software

Adjustment module is an adjustment tool with 4 buttons to click on. It also has a transparent window to allow display reading.

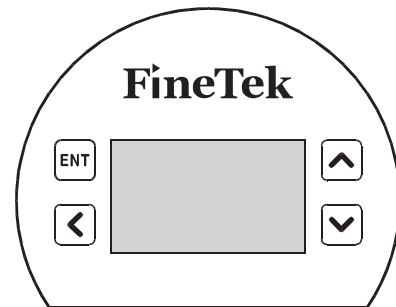

5 digits LCM display

[ENT] Button

- Enter Edit status
- Confirm Edit
- Confirm parameter modification

[←] Button

- Select Edit
- Select parameter
- Parameter

[↑] Button

- Return
- Cancel

[↓] Button

- Increase
- Select

WIRING DIAGRAM

JFR-1

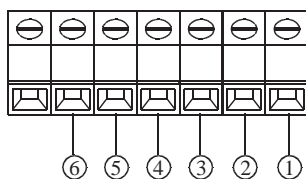

JFR-2

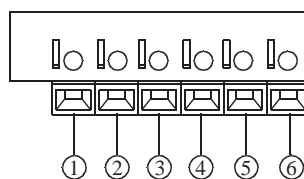

- ① Power Supply: V+
- ② Power Supply: V-
- ③ Analog Output: I+ (4~20mA)
- ④ Analog Output: I- (4~20mA)
- ⑤ Communication: TR+ (RS485)
- ⑥ Communication: TR- (RS485)

PARAMETER SETTING

Measurement bench-mark starts at contact surface of connection.

- ① Low level calibration
- ② High level calibration
- ③ Blind Distance
- ④ Measuring Distance Setup

Note: Be aware of blind distance when measuring material high level.(Shown in ③)

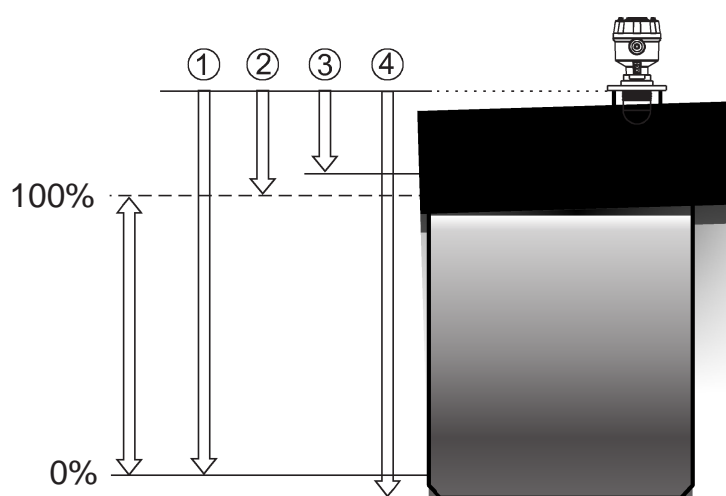

SOFTWARE SETUP CALIBRATION

Software Setup Calibration(FAS)

FAS calibration software can be utilized with JFR Series via RS485/RS232 to allow tank data reading and setup from PC.

Parameter Description

Low Point: Low point(4mA), measuring range from flange to low level.

High Point: High point(20mA), measuring range from flange to high level.

Blind Area: Blind distance, distance starts from flange surface.

Max. Distance: Measuring range between low point and high point.

FAS Operation Instruction

1. Turn on FAS software
2. Go to Address, then choose 9600, COM5 from baudrate
3. Click on Connect.
4. Press "Stop Sync" to change parameter.
5. Press "GetFFT" to read wave reflection diagram.
Press "Stop Sync" to change preset parameter.

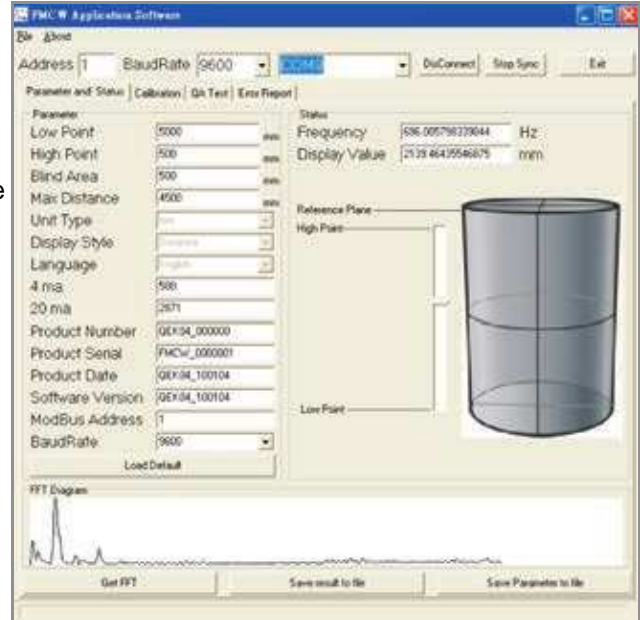

INSTALLATION

1. Installation in the extension tube

1-1 JFR-13 series installation with extension tubes inside the tank, extension tube length and diameter is required to meet the requirements.

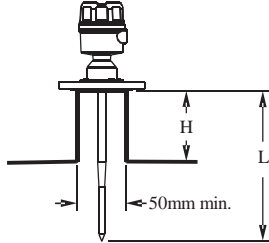

Model	Antenna length L	Extension tube length
JFR-13F	425 mm	H £ 160
JFR-14F	625 mm	H £ 360
JFR-15F	825 mm	H £ 560

1-2 JFR-10 and JFR-11 series horn antenna can be hidden in the extension tube the recommendation of the tube diameter D and length L are shown in the table.

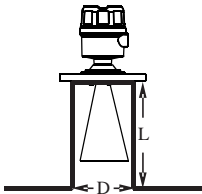

Model	Diameter D (mm)	Length L (mm)
JFR-10	D > 140	L £ 270
JFR-11	D > 100	L £ 140

1-3 JFR-204 can be hidden in the extension tube, the recommendation of the tube diameter D and length L are shown in the table.

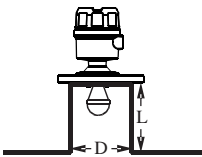

Diameter D (mm)	Length L (mm)
50	L £ 160
70	L £ 220
85	L £ 260
110	L £ 330

1-4 JFR-214 can be hidden in the extension tube, the recommendation of the tube diameter D and length L are shown in the table.

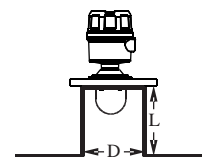

Diameter D (mm)	Length L (mm)
70	L £ 60
85	L £ 100
110	L £ 170

1-5 JFR-224 and JFR-234 can be hidden in the extension tube, the recommendation of the tube diameter D and length L are shown in the table.

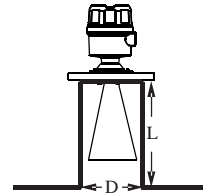

Model	Diameter D (mm)	Length L (mm)
JFR-224	D > 100	L £ 140
JFR-234	D > 140	L £ 270

1-6 JFR-244 can be hidden in the extension tube, the recommendation of the tube diameter D and length L are shown in the table.

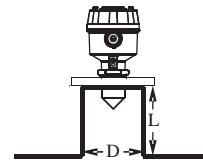

Diameter D (mm)	Length L (mm)
2"	L £ 100
2-3/4"	L £ 150
3-3/8"	L £ 230
4-3/8"	L £ 380

1-7 Installation recommendations are as follows :

1. Antenna installation angle to be perpendicular to the Horizontal.
2. JFR installation position with the drum wall suggestions Are as follows :
Installation location A should be less than 1/6D
Range with A relation is as follows :
a. H < 10m, A > 300mm
b. 10m < H < 20m, A > 600mm
c. H > 20m, A > 900mm

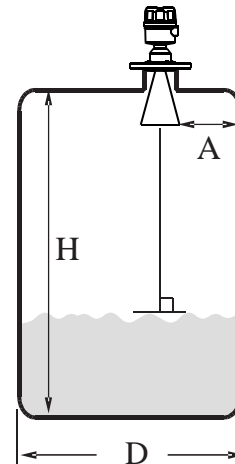

INSTALLATION

2. Radar installation should not be too close to the drum wall, avoid the drum wall attachment material reflection interference.

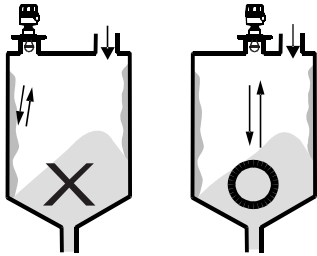

3. Radar installation not too close to the drum bracket to avoid reflection is incorrect

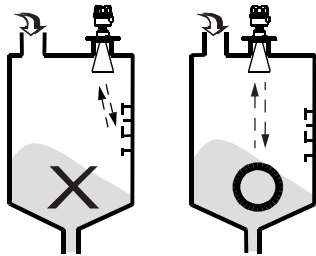

4. When obstructions inside the tank, tank be fitted with effectors, steer clear of the error echo reflected to the receiver, causing radar miscalculation.

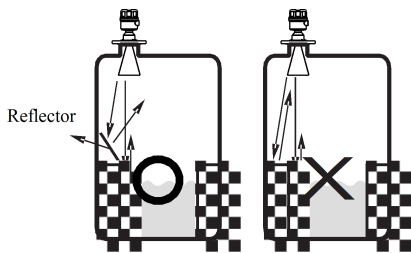

5. Outdoor installation should take shade or rain-proof measures.

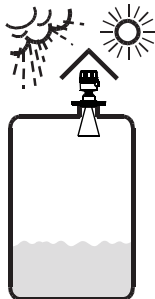

6. If drum internal agitator will have a strong vortex and foam, drum must increase waveguide, the upper waveguide drill vent holes to ensure the correctness of the measured value.

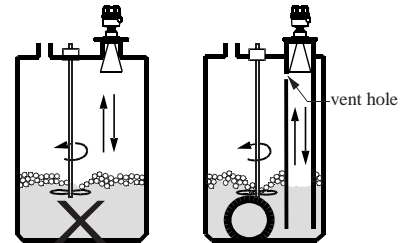

7. Installation should be avoided in the feed inlet position, avoid material interference or obstacles interference.

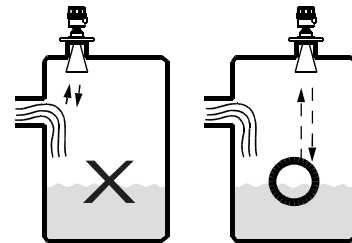

8. Installation should be avoided in the top center of the arch or round barrel will cause multiple echo reflections.

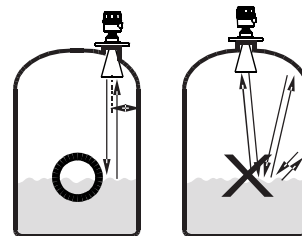

ORDERING INFORMATION(26GHz)

JFR-2 - - - 0

Antenna type

- 0:Horn(43D)
- 1: Lens(56D)
- 2: High gain Horn(100D)
- 3: High gain Horn(140D)
- 4: Lens(43DS)

Wiring

- 4: 4-Wire

Accuracy

- P: A 3mm A: A 5mm B: A 10mm

Connection type

- 0:Flange
- 1: Thread

Connection specification

Size for flange or screw	
E: 1-1/2"(40A)	I: 4"(100A)
F: 2" (50A)	J: 5"(125A)
G: 2-1/2"(65A)	K: 6"(150A)
H: 3" (80A)	S: Others

Pressure range or other	
M: 5kg/cm ² JIS	W: PN10 (10Bar)
N: 10kg/cm ² JIS	X: PN16 (16Bar)
O: 150Lbs ANSI	Y: PN25 (25Bar)
P : 300Lbs ANSI	Z: PN40 (40Bar)
R : PF	S: Others
U : NPT	

- (1)JFR-204 thread connection 1-1/2" only
 - (2)JFR-214 thread connection 2" only
 - (3)JFR-224 thread connection 1-1/2" only
 - (4)Please do check Radar antenna can be direct fitted in flange connection and nozzle
- Below is the suggestion

Type	Opening	Flange size
JFR-214	56mm	2-1/2"
JFR-224	100mm	4"
JFR-234	140mm	6"
JFR-244	44mm	2"

Flange material

- Metal 0 : SUS304 5: SS41 zinc coating 6: SUS316
- Plastic P: PP E: PTFE

ORDERING INFORMATION(10GHz)

JFR-1 - - 0 - 0 - R01

Type

- 0: Horn Antenna Type3
(Length 202mm,opening140mm) Standard
- 1: Horn Antenna Type2
(Length 126mm,opening100mm)
- 3: Rod Antenna
(Length 425mm) Standard
- 4: Rod Antenna
(Length 625mm)
- 5: Rod Antenna
(Length 825mm)

Material

- 0: SUS304---Horn Antenna
- 6: SUS316---Horn Antenna
- E: ETFE-----Horn Antenna with ETFE coating
- F: PTFE-----Rod Antenna

Accuracy

- A: A 5mm B: A 10mm
- C: A 20mm D: A 30mm

Flang connection

Size for flange or screw	
G: 2-1/2"(65A)	I: 4"(100A)
H: 3" (80A)	J: 5"(125A)
	K: 6"(150A)
	S: Others

Pressure range or other	
M: 5kg/cm ² JIS	W: PN10 (10Bar)
N: 10kg/cm ² JIS	X: PN16 (16Bar)
O: 150Lbs ANSI	Y: PN25 (25Bar)
P : 300Lbs ANSI	Z: PN40 (40Bar)
	S: Others

※ Please do check Radar antenna can be direct fitted in flange connection and nozzle
Below is the suggestion

(1) Horn Antenna

Type	Opening	Flange size
Type3	140mm	6"
Type2	100mm	4"

(2) Rod Antenna

Minimum size of flange is 2-1/2"

Flange material

- Metal 0: SUS304 5: SS41 zinc coating 6: SUS316
- Plastic P: PP E: PTFE

Selection Guide for Solid/Liquid Level Measurement

- [FC/FD] Mini Float/Magnetic Float Level Switch
- [FG] Magnetic Float Level Transmitter
- [FF] Side Mounting Float Switch
- [FA/FB] Cable Float Level Switch
- [SP] Thermal Dispersion Flow Switch
- [SF] Paddle Flow Switch
- [SD] Optical Level Switch
- [SE] Rotary Paddle Level Switch
- [SA] Capacitance Level Switch
- [EC] Pressure Level Transmitter
- [SC] Vibrating Probe Level Switch
- [SC] Tuning Fork Level Switch
- [EB] RF-Capacitance Level Transmitter
- [SB] RF-Capacitance / Admittance Level Switch
- [EG] Magnetostrictive Level Transmitter
- [EF] By-Pass Level Transmitter
- [MEF] Mini By-Pass Level Transmitter
- [EA] Ultrasonic Level Transmitter
- [JFR] FMCW Radar Level Transmitter
- [EE] Electromechanical Level Measuring System
- [ED] Speed Monitor
- [SRT/SRS] Conveyor Belt Misalignment Switch & Safety Cable Pull Switch
- [PB/PM] Microprocessor Based Bargraphic Display Scaling Meter
- [BRD/AE] Valve and Controller for Dust Collector System
- [BAS/BAH/BVP] Air Hammer
- [BVK/BVR/BVT] Pneumatic Vibrator

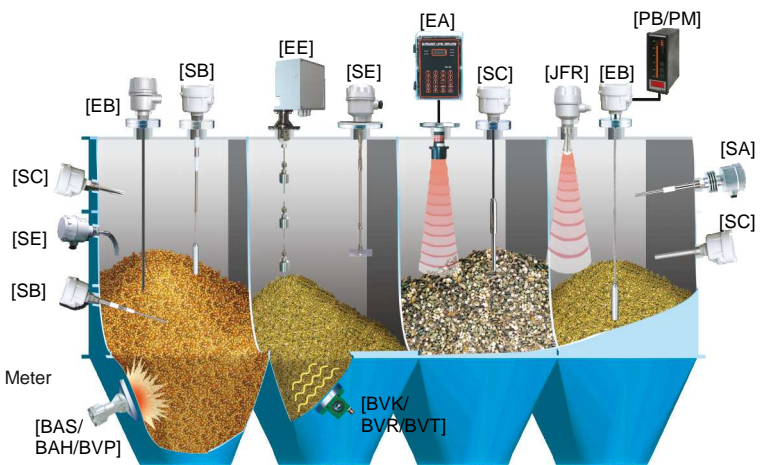
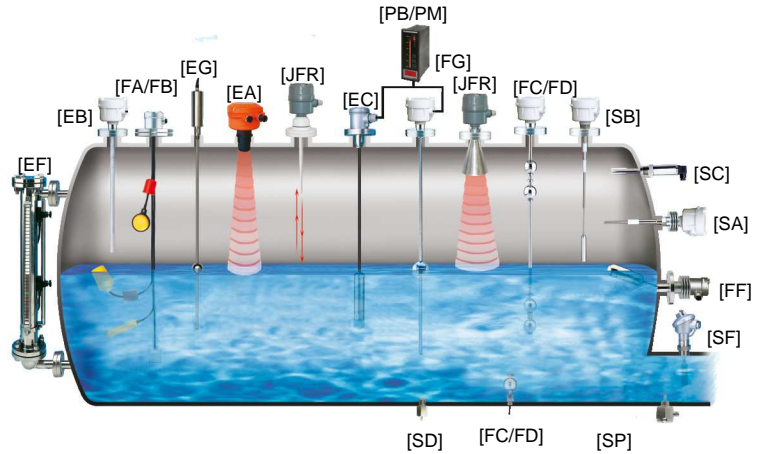

TELEMETRIX SAS
79, RUE DE LA GARE
BP118
FR-78370 PLAISIR

Tel. (+33) (0) 972 11 00 03
Fax (+33) (0) 972 11 00 03
www.direct-mesure.fr
contact@direct-mesure.fr

N° TVA FR85418256814
RCS B 418 256 814
SIRET 418 256 814 00041



Distributor: