



Série Débitmètre electromagnetique
EPD Electromagnetic Flow Meter



www.telemetrix.fr



TeleMetrix

FLOW MEASUREMENT FIELD



FineTek is the only inspection institution that owns a Class 2 flow test laboratory in Taiwan. With the most professional R&D and Design Team, it can design and develop high-accuracy electromagnetic flow meters. Moreover, it conducts calibration in Class 1 Flow Laboratory of the National Measurement Laboratory (ITRI Measurement Center), so as to guarantee the flow accuracy on the measurement field.

FineTek's flow laboratory has received certification from the Taiwan Accreditation Foundation and conforms to the regulations of international organizations such as ILAC and APALC. It has the complete ability of uncertainty testing and rating for flow test.

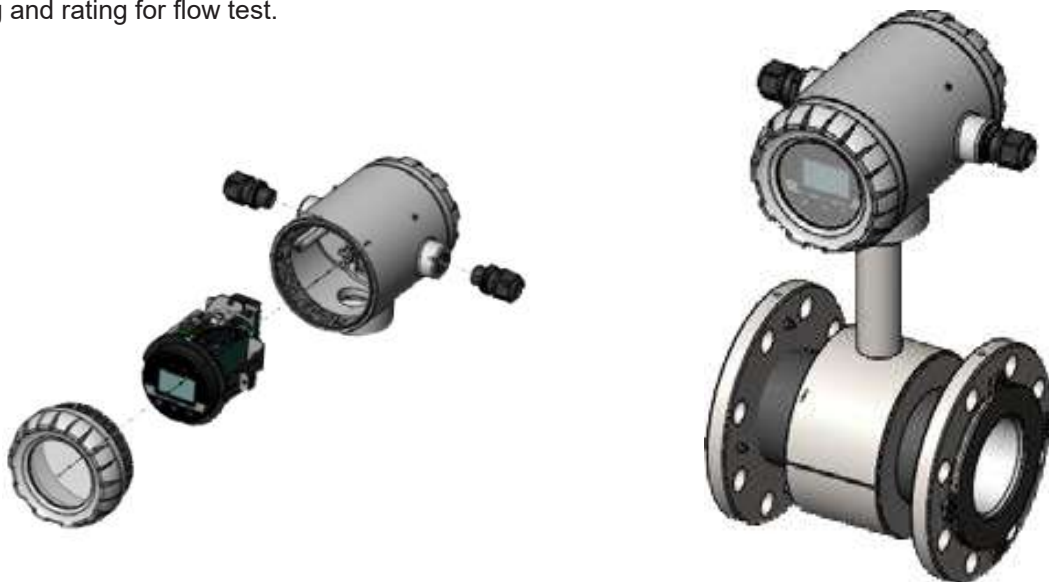



Certificate No. : L3086-150625

財團法人全國認證基金會
Taiwan Accreditation Foundation

Certificate of Accreditation

This is to certify that

Fine Tek Co., Ltd.

Quality Center Testing Laboratory

No.16, Ziqiang St., Tucheng Dist., New Taipei City 236, Taiwan (R.O.C.)

is accredited in respect of laboratory.

Accreditation Criteria : ISO/IEC 17025: 2005
Accreditation Number : 3086
Originally Accredited : June 25, 2015
Effective Period : June 25, 2015 to June 24, 2018
Accredited Scope : Testing Field, see described in the Appendix

Jay-San Chen
President, Taiwan Accreditation Foundation
Date : June 25, 2015

PI, total 2 pages

The Appendix forms an integral part of this Certificate, which shall be invalid when use without the Appendix



Certificate No. : L3086-150625

財團法人全國認證基金會
Taiwan Accreditation Foundation

Accreditation Number : 3086

Laboratory Head : CHANG, Jeremy

17.95 Metrical Instrument

Water Flowmeter

M205 Total Amount of Water

In-House Test Method, Document No.: QW-05-26

(0.085 to 720) m³ @ (1.7 to 180) m³/h

Approval Signatory: CHANG, Jeremy;PENG, Harris

Testing Place: No.26, Ding'an Rd., Su'ao Township, Yilan County, Taiwan (R.O.C.)

19.01 Electronic and Electric

Process Automation Sensors, Motors Pneumatic Control Components,

Power Electronics and Control Instruments, Water Flowmeter

E003 Temperature/Humidity Combination Test

IEC 60068-2-38

Temperature: (-10 to 65) °C

Humidity: 93 %RH

Approval Signatory: CHANG, Ting-Wei;CHANG, Jeremy;PENG, Harris

E003 Vibration

MIL-STD-202 Method 201A

Frequency: (10 to 55) Hz

Displacement: (0 to 0.76) mm

Approval Signatory: CHANG, Ting-Wei;CHANG, Jeremy;PENG, Harris

(Null below)

ELECTROMAGNETIC FLOW METER

EPD electromagnetic flow meter is a high-accuracy flow meter manufactured based on the latest international technology. It is widely applied in papermaking, chemical industry, metallurgical industry, drainage, waste water treatment, liquid high-pressure metering, medical care, food, and environmental protection industries. It is used to measure the non-magnetic liquid and plasma in the enclosed pipe.

WORKING PRINCIPLE

The working principle of the electromagnetic flow meter is based on the Faraday law of electromagnetic induction. When the conducting liquid flows in the orthogonal direction of the magnetic line direction, it will cut the magnetic lines and generate induced voltage, which shows linear relationship with the flowing speed. Thus, the fluidic volume flow can be calculated.

EPD electromagnetic flow meter is mainly composed of the sensor and transmitter. The measuring tube of the sensor is equipped with the excitation coils upward and downward. The transmitter supplies the excitation current, which generates the magnetic field which goes through the measuring tube once it is powered on. A pair of induction electrodes installed on the inner side of the measuring tube comes in contact with the liquid to guide the induced voltage to the sensor.

APPLICATIONS

- Waste water treatment
- Tapped water purification
- Sewerage
- Sea water desalination module
- Dyeing machines
- Solar energy and PCB wet processing
- Food manufacturing
- Pharmaceutical machines

FEATURES

- The measurement results are not affected by the change in liquid density, viscosity, temperature, pressure and conductivity.
- Power-saving and low fault rate: The measuring tube is without baffle and movable parts, so it won't cause pressure loss and jam.
- It can be widely applied in the conducting liquids that may contain fiber, solid granules and suspended matters.
- It is easy-to-install with low requirements for the straight tube section (Front 8D and rear 5D).
- The wide measurement turndown ratio can reach 1:100, which can be set randomly and achieve high accuracy for small flow measurement.
- Protection rating: Integrated type DN40~DN200 (IP67/NEMA 4X)
- Highly-integrated backlit display of two rows, dual isolation, parameter setting, menu-type operation, memory function, reliable programming, password lock and access, small signal elimination, non-linear correction and two-way measurement.
- Smart self-detection and self-diagnosis function, as well as various alarms.
- Various outputs: Current output 4~20 mA/0~10 mA, frequency output 1~8kHz and RS485 communication.
- Various options of lining and electrode material, applicable to different media.

TELEMETRIX est distributeur officiel **FINETEK** leader mondial de la mesure de niveau
TELEMETRIX SAS BP1118 FR-78370 PLAISIR

Tel. (+33) (0) 972 11 00 03 Fax (+33) (0) 972 11 00 03 www.direct-mesure.fr contact@direct-mesure.fr
N° TVA FR85418256814 RCS B 418 256 814 SIRET 418 256 814 00041

SPECIFICATION

Item	EPD30
Display	LCM 128*64 pixel backlit type
Buttons	Tri-button operation
Communication interface	RS-485 (Modbus) (Optional support for ZigBee Pro wireless transmission)
Accuracy	±0.5% of reading@1m/s(0.2% optional)
Medium temperature	- 20 ~ 120 °C
Ambient temperature	- 40 ~ 70 °C ¹
Fluidic conductivity	>5 uS/cm
Measuring scope	0.1m/s ~ 10m/s
Current output accuracy	0.1% of Pulse Output Accuracy Temperature coefficient (20ppm/ °C)
Current output mode	Proactive
Analog output	4 ~ 20mA
Maximum load of current output	< 700 Ω
Alarming current	3.5mA or 23 mA
Frequency output scope	0.01 ~ 8,000 Hz
Pulse width	Automatic (pulse width 50%)
Pulse mode	NPN transistor output 32vdc/200mA
Time constant	0.1~20 s
Control output (DO)	NPN transistor output 32vdc/200mA ;2-CH
Control input (DI)	Dry contact ON< 200 Ω ; 1,000 Ω < OFF ; 1-CH
Baud rate	1200 ~ 38400 bps
Protection rating	IP67 / NEMA 4X
Enclosure material	Aluminum alloy
Input power	AC 100~240 Vac
Power consumption	< 10W
Wire inlet specification	M20 x 1.5*2 Female
Excitation mode	Pulse DC
Vibration regulation	IEC 60068-2-3
EMC regulation	IEC/EN 61326-1 Class A table2

¹ It can't display when LCM is lower than -20°C.

MATERIAL SELECTION

※Electrode material

Electrode material	Anti-corrosion property
Stainless steel (316L)	It is applied in water, sewage and organic and non-organic corrosive medium.
Hastelloy alloy	It is resistant to the corrosion of the medium mixture of oxidizing acid such as Nitric acid, mixed acid or Sulfuric acid. Moreover, it is resistant to the corrosion of the oxidizing salt such as Fe^{2+} , Cu^{2+} or other substances containing oxidants such as the salt solution of hypochlorous acid above the ambient temperature and sea water.
Titanium	It is resistant to the corrosion of sea water, various oxides, salt solution of hypochlorous acid, oxidating acid (including fuming Nitric acid) and organic acid and alkane. It is not resistant to the corrosion of pure reducing acid (such as Sulfuric acid and Hydrochloric acid). However, the anti-corrosion property will be greatly degraded if the acid contains some oxidants.

※Lining material

Lining material	Main properties	Application scope
PTFE	<ol style="list-style-type: none"> 1. Stable chemical properties, resistant to various acid, alkane, and salt solutions and various organic solvents. It is not tolerant to the corrosion of ClF_3, high-temperature OF_3 and high-speed liquid oxygen and ozone. 2. The anti-abrasion property is average. 	<ol style="list-style-type: none"> 1. - 20~120°C 2. Strong corrosive medium such as concentrated acid and alkane.

APPEARANCE AND DIMENSION AND FLANGE CONNECTION DIMENSION

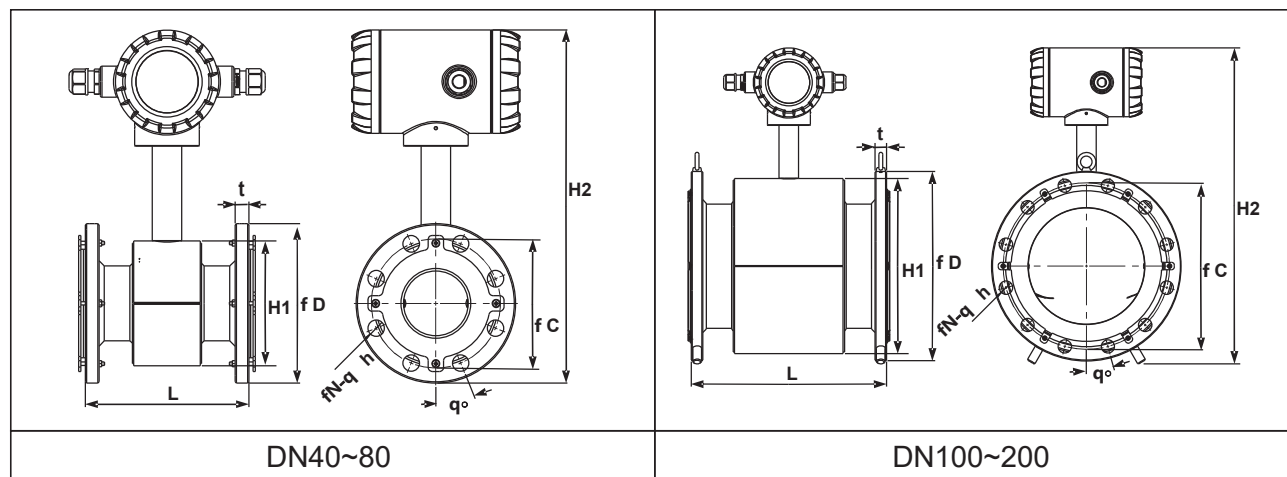

Connection specification		JIS 10K							
Nominal diameter(mm)		40	50	65	80	100	125	150	200
Lining material		PTFE							
Length	L	200	200	200	200	250	250	300	350
External diameter	f D	140	155	175	185	210	250	280	330
PCD	f C	105	120	140	150	175	210	240	290
Flange thickness	t	14	14	16	16	16	20	22	22
Inclined angle of screw hole	q°	45	45	45	22.5	22.5	22.5	22.5	15
Diameter of screw hole	qh	19	19	19	19	19	19	23	23
Quantity of screw holes	N	4	4	4	8	8	8	8	12
Height of sensor casing	H1	125	125	145	145	195	195	270	305
Total height	H2	329	336	356	361	398.5	418.5	481	520
Weight (kg)		6.8	7.68	8.98	9.87	12.9	17.5	23.51	33.23

Connection specification		ANSI 150Lbs							
Nominal diameter(mm)		40	50	65	80	100	125	150	200
Lining material		PTFE							
Length	L	200	200	200	200	250	250	300	350
External diameter	f D	127	152	178	190	229	254	279.4	342.9
PCD	f C	98.4	120.6	139.7	152.4	190.5	215.9	241.3	298.4
Flange thickness	t	15.9	17.4	20.6	22.2	22.2	22.2	23.8	27.0
Inclined angle of screw hole	q°	45	45	45	22.5	22.5	22.5	22.5	22.5
Diameter of screw hole	qh	15.9	19	19	19	19	22.2	22.2	22.2
Quantity of screw holes	N	4	4	4	8	8	8	8	8
Height of sensor casing	H1	125	125	145	145	195	195	265	305
Total height	H2	322	335	358	364	408	421	478	525

Remarks: For DN40~DN80, the lining protective ring is 2mm, so the total length of the flow meter shall be increased by 4mm. For DN100~DN200, the lining protective ring is 0.5mm, so the total length of the flow meter shall be increased by 1mm; total height (H2) tolerance is $\pm 2\text{mm}$

PIPE DIAMETER, FLOW RANGE AND ACCURACY SELECTION

Pipe diameter (mm)	Flow range q_v / h^3)
	Flowing speed 1.0~10m/s
40	4.5~45.2
50	7.1~71
65	11.9~119
80	18.1~181
100	28.3~283
125	44.2~442
150	63.6~636
200	113~1130

INSTALLATION INSTRUCTIONS

1. The flow meter must be free from strong electromagnetic field. The magnetic intensity of the flow meter installation site must be smaller than 400A/m (It should not be installed near large motors or transformers).
2. It should be installed at the lower point and the vertically upward point of the horizontal pipe. Don't install it at the highest point and the vertically downward point of the pipe.

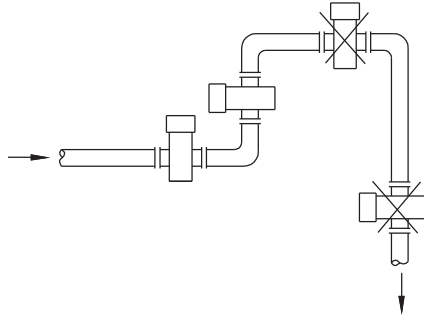

3. It should be installed at the rising point of the pipe.



4. It should be installed at the lower point of the pipe when it is installed on the pipe with opening for drainage.

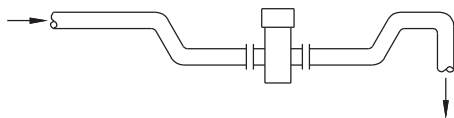

5. If the pipe gap exceeds 5m, the air release valve should be installed at the downstream of the sensor. The downstream of the sensor should have some back pressure.

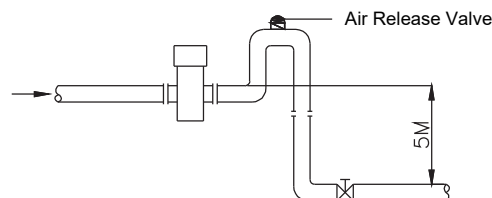

6. The control valve and cut valve should be installed at the downstream of the sensor rather than the upstream.

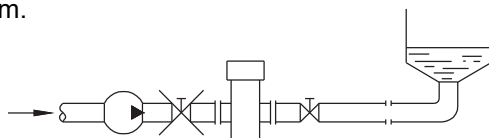

7. The sensor should be installed at the pump outlet rather than the inlet.

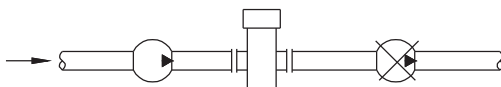

8. The fluidic must flow towards the arrow direction of the flow meter.
9. The axial line of the measuring electrode must be approximate to the horizontal direction (The angle of from the horizontal direction).
10. The measuring pipe must be completely filled with liquid.

11. The straight tube section is required to be at least 5D (internal diameter of the flow meter) on the front side, and at least 2D on the rear side.

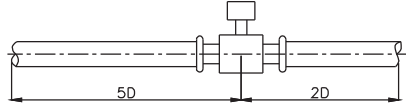

12. When measuring the mixture of different media, the distance between the mixing point and the flow meter must be 30D at least.
 13. For convenient cleaning and maintenance of the flow meter, a bypass pipe must be installed.

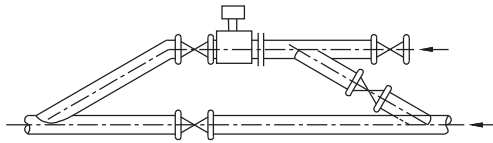

14. When installing the sensor, it should ensure that the measuring pipe and the process pipe must be on the same axial line. For the flow meter with the pipe meter of 50mm or below, the axial line deviation should not exceed 2mm. For those of DN65 ~ DN150, the axial line deviation should not exceed 3mm. For those of \geq DN200, the axial line deviation should not exceed 4mm.
 15. The shim installed between the flanges should have excellent anti-corrosion property. The shim should not intrude in the pipe, which will affect the fluidic in the pipe.
 16. The sensor and transmitter should be equipped with high-quality independent grounding wire (The section area of the copper core is 1.6mm²). The grounding resistance should be $<10 \Omega$. If the grounding is poor, it won't work normally. The grounding ring is needed if the pipe connecting with the sensor is insulating, and the material of the grounding ring should be the same as that of the electrode. If the test medium is abrasive, the neck grounding ring should be selected.

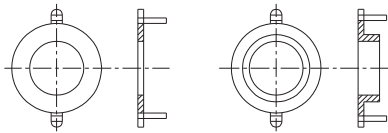

- 16.1 It is for installing the flow meter on the metal pipe not coated with insulating layer internally.

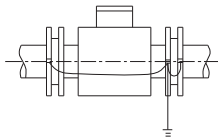

- 16.2 When installing the flow meter on the protective pipe of the cathode, the pipe with the protection of electrolytic corrosion generally has insulating walls and protruding sides. Thus, during installation, the grounding ring and the flanges on the pipe should be insulating.

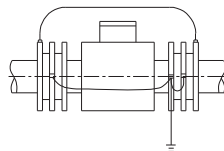

- 16.3 When installing the flow meter on the plastic pipe or the pipe with insulating coating material, paints or lining, grounding rings on both ends of the sensor should be installed.

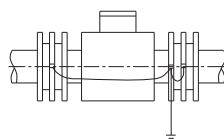

ORDERING INFORMATION

EPD30 5 E L N J 2 F 0

Pipe Diameter

- 040: 40mm 100: 100mm
- 050: 50mm 150: 150mm
- 065: 65mm 200: 200mm
- 080: 80mm

Connection Specification

- | | | |
|--------------------------|------------|---------|
| M: 5kg/cm ² | O: 150Lbs | W: PN10 |
| V: 7.5Kg/cm ² | P: 300Lbs | X: PN16 |
| N: 10Kg/cm ² | H: 600Lbs | Y: PN25 |
| F: 16Kg/cm ² | S: Special | Z: PN40 |
| G: 20Kg/cm ² | | |

Casing and Flange Material

- 5: Carbon Steel

Lining Material

- E: PTFE

Electrode Material

- L: SUS316L
- H: Hastelloy alloy C276
- T: Titanium

Electrode Type

- N: Normal Type

Power Supply and Signal Transmission

- J2: Integrated Flow Meter , 100~240 Vac 50/60Hz, 4-20mA, pulse output, RS-485

Accuracy

- A: 0.2%
- F: 0.5%
- G: 1.0%

Grounding Ring

- : None
- 0: SUS 304
- L: SUS316L
- H: Hastelloy alloy C276
- T: Titanium

SETTING VALUES

Easy Setting

No.	Parameter Option	Unit	Default	Value	Remarks
1	Device Tag Num	none	00001		
2	Zero adjustment	m/ s	actual		
3	Flow Span	-	Permitted maximum value		
4	Flow Rate Unit	-	Liter		
5	Low flow Cutoff	%	0.5		
6	Damping Time	Second	1		
7	Pulse Output Unit	Unit/pulse	0.01L		
8	Total reset	-	Cancel		

Basic Setting

No.	Parameter Option	Unit	Default	Value	Remarks
1	Device Tag Num	none	00001		
2	Zero adjustment	m/ s	actual		
3	K-Factory	-	1.000		
4	Tube Size	10~100 mm	mm	actual	
		125~500 mm	mm	actual	
5	Flow Rate Unit	-	Liter		
6	Flow Span	-	Permitted maximum value		
7	Liquid Density	g/ cm ³	1.0000		
8	Low flow Cutoff	-	0.5		
9	Flow Direction	-	Forward		
10	Total Unit	-	M ³		
11	Total Mode	-	Forward		
12	Total Reset	-	Cancel		
13	Fwd. Total Init.	-	0		
14	Rev. Total Init.	-	0		

I/O Signal Setting

No.	Parameter Option	Unit	Default	Value	Remarks
1	Damping Time	Second	1		
2	Pulse Output Mode	-	Pulse NO		
3	Pulse Output Unit	Unit/pulse	0.01 L		
4	Max. Frequency	HZ	2000		
5	Output Curr. Mode	-	4-20		
6	4mA Fine-Tune	count	0		
7	20mA Fine-Tune	count	0		
8	Digital 1 In Func	-	None		
9	Digital 1 In Type	-	NO		
10	ModBus Comm.	Modbus ID	-	1	
		BaudRate	-	9600	
		Data bit	bit	8	
		Parity	-	none	
		Stop bit	bit	1	

Alarm Setting

No.	Parameter Option	Unit	Default	Value	Remarks
1	Max. Flow Rate	-			
2	Min. Flow Rate	-			
3	Empty Tube Detct	-	Disable		
4	Output 1 func.	-	Higher than the upper limit of flow rate		
5	Output 1 type	-	NO		
6	Output 2 func.	-	Higher than the upper limit of flow rate		
7	Output 2 type	-	NO		
8	Curr. Func.	-	N/A		
9	Alarm Curr. Val.	mA	NO		

System Setting

No.	Parameter Option	Unit	Default	Value	Remarks
1	System language	-	Traditional Chinese		
2	System info.	Status of measuring pipe	-	actual	
		Current flowing speed	m/s	actual	
3	Self-diagnosis	-	Cancel		
4	Recovery Default	-	Cancel		

Simulation

No.	Parameter Option	Unit	Default	Value	Remarks
1	Flow Speed	m/s	0		
2	Flow Rate	-	0		
3	Output Curr.	mA	4		
4	Output Freq.	Hz	0		
5	Output 1 status	-	ON		
6	Output 2 status	-	ON		
7	Digital In Set	-	ON		

Infomation

No.	Parameter Option	Unit	Default	Value	Remarks
1	Converter No.	-	actual		
2	Firmware version	-	actual		

EXAMPLES OF TANK-MOUNTING

- [EC/FD] Mini Float/Magnetic Float Level Switch
- [FG] Magnetic Float Level Transmitter
- [FF] Side Mounting Float Switch
- [FA/FB] Cable Float Level Switch
- [SP] Thermal Dispersion Flow Switch
- [SF] Paddle Flow Switch
- [SD] Optical Level Switch
- [SE] Rotary Paddle Level Switch
- [SA] Capacitance Level Switch
- [EC] Pressure Level Transmitter
- [SC] Vibrating Probe Level Switch
- [SC] Tuning Fork Level Switch
- [EB] RF-Capacitance Level Transmitter
- [SB] RF-Capacitance / Admittance Level Switch
- [EG] Magnetostrictive Level Transmitter
- [EF] By-Pass Level Transmitter
- [MEF] Mini By-Pass Level Transmitter
- [EA] Ultrasonic Level Transmitter
- [JFR] FMCW Radar Level Transmitter
- [EE] Electromechanical Level Measuring System
- [ED] Speed Monitor
- [SRT/SRS] Conveyor Belt Misalignment Switch & Safety Cable Pull Switch

- [PB/PM] Microprocessor Based Bargraphic Display Scaling Meter
- [BRD/AE] Valve and Controller for Dust Collector System
- [BAS/BAH/BVP] Air Hammer
- [BVK/BVR/BVT] Pneumatic Vibrator

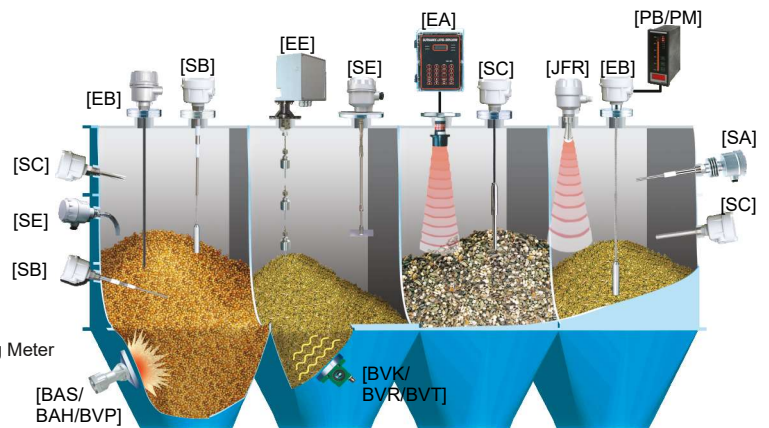
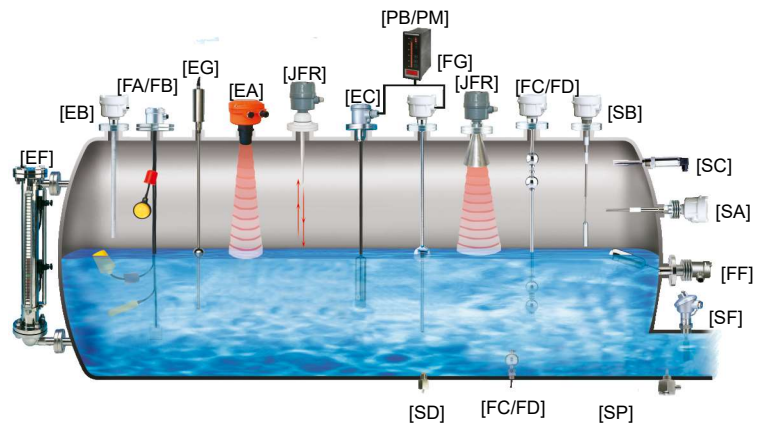

TeleMetrix

TELEMETRIX SAS
79, RUE DE LA GARE
BP118
FR-78370 PLAISIR

Tel. (+33) (0) 972 11 00 03
Fax (+33) (0) 972 11 00 03
www.direct-mesure.fr
contact@direct-mesure.fr

N° TVA FR85418256814
RCS B 418 256 814
SIRET 418 256 814 00041



Distributor: