

Centrifugal mass flowmeter for powder

CFM series

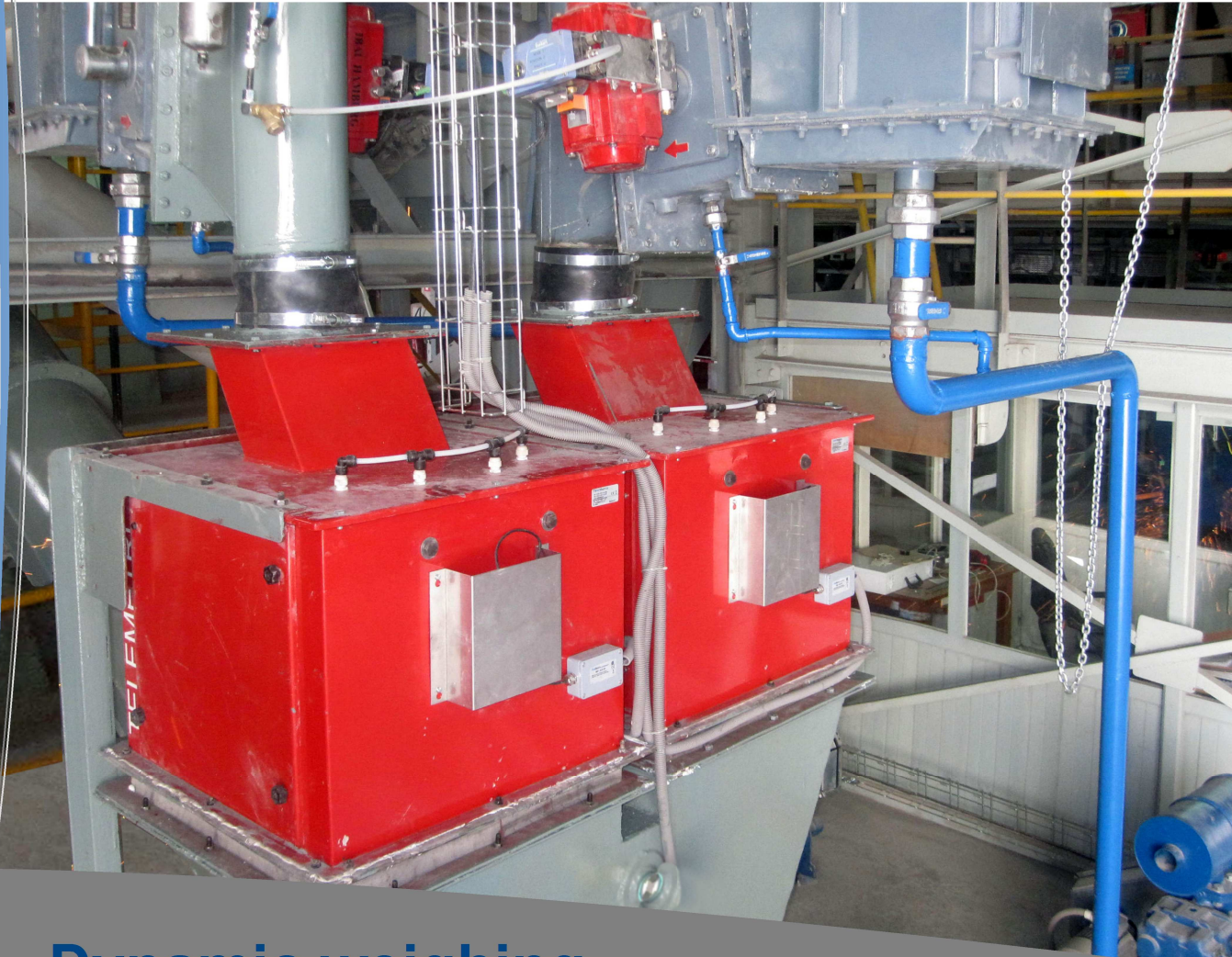

TeleMetrix



Dynamic weighing

Flow measurement and continuous weight totalizer for:

- Cement, lime and mineral powder
- Cereal, Grain and seeds
- Animal feed, pet-food
- Sugar, flour plastic
- Plastic pellets and recycling ground
- Wood chips

CFM Series mass flowmeter

For flow rates from 2 to 600 t/h (4 to 500 m³), the CFM flowmeters solid product continuously measures a flow of materials by the principle of centrifugal force.

The flowmeter is designed for large volumes ensuring passages without disturbing the upstream and downstream process.

Dustproof and without electric circuit in the measuring zone, the flow meter is suitable for all use in hazardous ATEX areas with high temperature products and adhesive products.

In terms of maintenance, the request tends to be minimal, plus, calibrations of tested material remains reliable over the time.



Main Features

Flow rate (t/h for 1.0 density)	CFM45 45 t/h	CFM150 150 t/h	CFM500 500 t/h
Accuracy	1 % to 2 %		
Granulometry	0 – 30 mm		
Fixation	free-standing or wall mounting (The meter must be installed on a single chassis vibration)		
Terms and conditions	-10°C à 40°C Humidity 95% Waterproof IP66		
Finishing coat	3 coats of anticorrosion paint with phosphate. Inox wear plates. Option : Version INOX 316 L		
Installation on ATEX zone	Option : ZONE 20,21,22		

Exemples d'installations



Loading control for bulk cement trunk under silo

250 t/h +- 1 %



Storage and flux management in cereal storing silos.

150 t/h +- 1 %



Continuous additive dosing until the lime bagging line.

100 t/h +- 2 %



Loading control of silo for wheat flour.

120 t/h +- 1 %



Production control for screening machine.

40 t/h +- 1 %

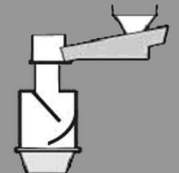
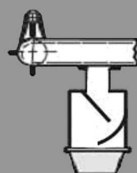

	Modèle de débitmètre		
	CFM 045	CFM 150	CFM 500
Débit	45 m3/h	150 m3/h	500 m3/h
Nb Capteur	1	2	2
Bride	PN10 DN200	PN10 DN300	PN10 DN400
A	694	843	1052
B	450 x 450	600 x 600	800 x 800
C	760	918	1200
D	510	660	860
E	306	381	481
F	117	109	115
G	503	574	615
H	430	584	784
I	215	292	392

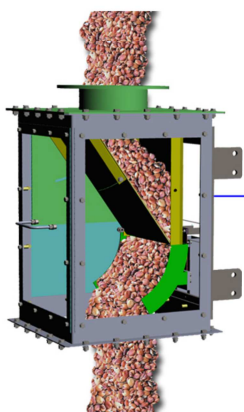
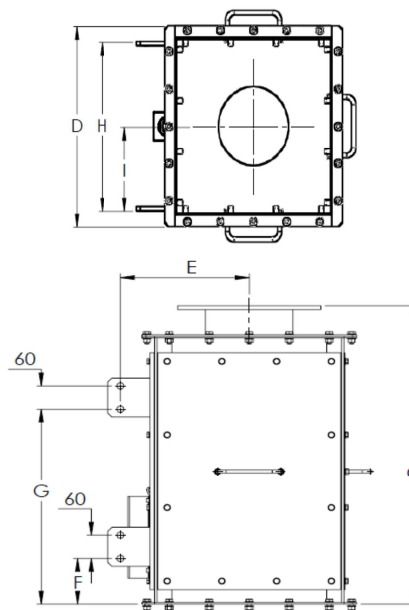

Entrée capteurs

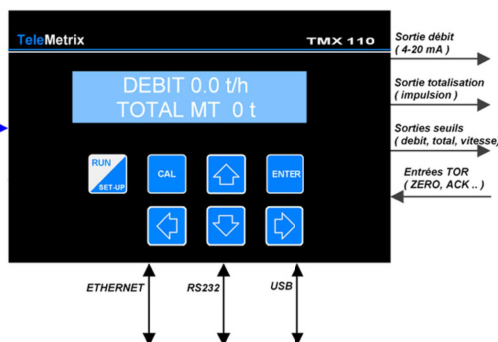

TMX110 Dynamic weight calculator integrator

- Alphanumeric display of values : debit, total weight, speed, anomaly ...
- Dynamic programme, dosing, weighing screw, flowmeter
- Multi-lingual display : English, French, Dutch, etc. (Available in other languages)
- Available with **WATERPROOF**, **FREE STANDING OR WALL MOUNTING**, **DIN RAIL (transmitter)**.
- Universal communication: standard analogue and numeric connections.
- Auto-calibration and/or testing methods.
- Configuration saving on USB stick.
- Overall auto-diagnostic of the weighing scale's component: sensors, E/S, etc...
- Online and USB updating of the firmware.



TMX400 Multi-connection weight calculator

- Clear display of numerical values: debit, total weight, speed, anomaly, up to 15 weighing scale's connections (NOD400 box).
- Multi-lingual display
- Compact housing wall or DIN rail mounting.
- Universal communication: ethernet, modbus, profibus, analogue connection, USB, ...
- Auto-calibration and/or testing methods.
- Easy setup et remote maintenance.



Our expertise

PRODUCTIVE APPLICATIONS

- Continous control and regulation process.
- Daily and weekly counting and totalisation
- Auto-control of truck or wagon loading.
- Stock management.

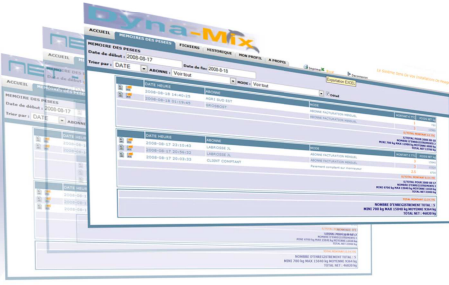
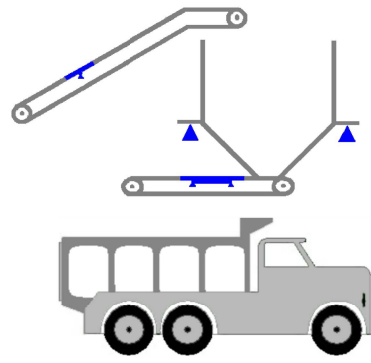

SOFTWARE SOLUTION

DYNAMIX is a software which offers you 3G functionality thus centralized measures, even on distant location. Our softwares ensure connectivity, performance and reliability for your installation.

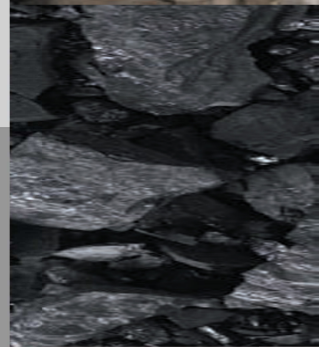
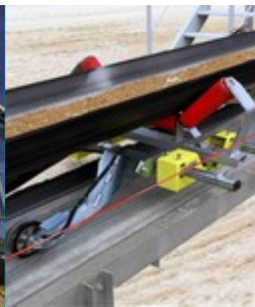

WEIGHING SCREW

La mesure est intégrée dans la chaîne de fabrication en continu de mélange sans adjonction de matériel supplémentaire. pas besoin de trémie tampon.

DOSING

Mini weighting belt conveyor allows debit control or continous loading control.

WEIGHING BELT SCALE

Weighing scale for belt conveyor suitable for industrial bulk products : harbour, mines and quarries.

DOSIMETER LWR

Hight precise continous dosing of podery and granule products with varied or fixed density.

STATIC WEIGHING

Weight or hopper placed under silos are precised way for level measurement.

SERVICE SUR SITE



Provide technical services in industrial weighing field: assembly , calibration, breakdown services as maintenance agreement. Our technicians have developed a great experience in the industrial dynamic weighing area with the regulatory requirements.

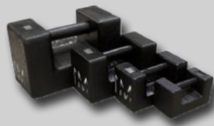

Calibration on site & commissioning
Test material and calibration mass



Products overview

Speed Controller

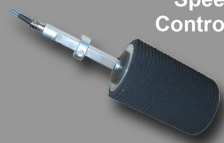

Pull rope stop Switch

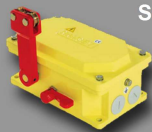

Tilt Switch Probes



Weight Sensor



Metal tramp Detector



SAS TELEMETRIX®
BP118 79, Rue de la Gare
7370 PLAISIR CEDEX France

Head office
Tél. (+33) 0972 11 00 03
Fax. (+33) 0972 11 00 57
contact@telemetrix.fr

SOUTH Office
(+33) 04 84 51 03 00
www.telemetrix.fr

Export
Europe, Afrique,
Asie, etc...
export@telemetrix.fr

Contact

